

PRODUCT OVERVIEW

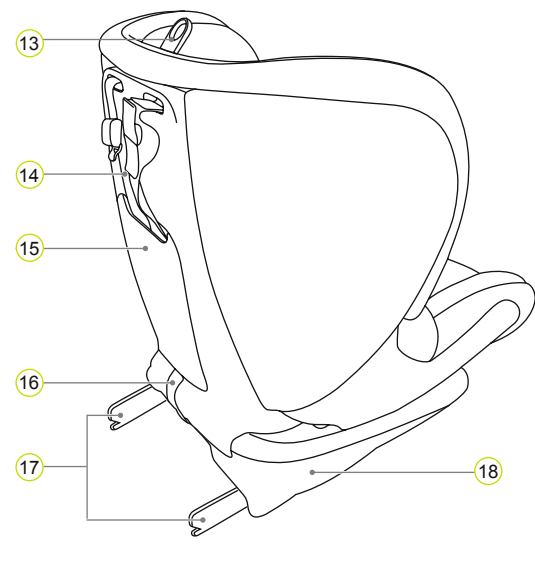
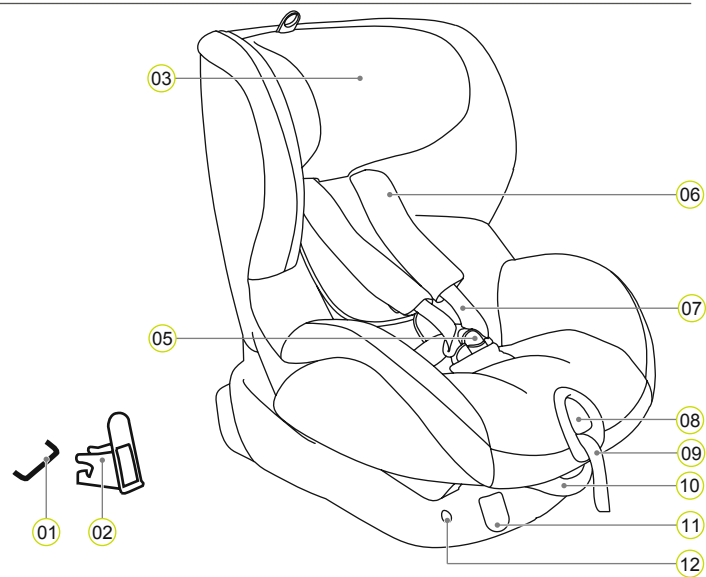

- 01 ISOFIX attachment points (car)
- 02 ISOFIX insert guides
- 03 Headrest
- 05 Harness buckle
- 06 Shoulder pads
- 07 Shoulder straps
- 08 Adjusting button
- 09 Adjustment strap
- 10 Recline handle
- 11 ISOFIX unlocking buttons
- 12 ISOFIX indicators
- 13 Adjusting ring of the headrest
- 14 Top Tether
- 15 User guide compartment
- 16 Fabric loop
- 17 ISOFIX locking arms
- 18 Seat shell

BRITAX RÖMER child safety seat	Tested and certified according to ECE* R 44/04	
	Group	Body weight
TRIFIX	1	9 bis 18 kg

The child safety seat has been designed, tested and certified according to the requirements of the European Standard for Child Safety Equipment (ECE R 44/04). The test mark E (in a circle) and the certification number are located on the orange certification sticker (sticker on the child safety seat).

- This certification will be invalidated if you make any modifications to the child safety seat.
- The TRIFIX child safety seat must only be used to secure your child in the vehicle. It must never be used as a seat or toy in the home.

*ECE = European Standard for Child Safety Equipment

CARE INSTRUCTIONS

- To ensure the full protective effect of the child safety seat:
- In the event of an accident with an impact speed above 10 km/h it is possible that the child safety seat may have been damaged, but that the damage may not be immediately obvious. In this case the child safety seat must be replaced. Please dispose of it properly.
- Regularly check all important parts for damage. Make sure that the mechanical components in particular are all in perfect working order.
- To prevent damage, ensure that the child safety seat does not become jammed between hard objects (car door, seat runners etc.).
- Always have the child safety seat checked if it has been damaged (e.g. if it is dropped).
- Never lubricate or oil parts of the child seat.

Please observe the waste disposal regulations in your country.

Disposal of packaging	Container for cardboard
Cover	Residual waste, thermal utilisation
Plastic parts	In accordance with the labelling in the designated container
Metal parts	Container for metals
Harness straps	Container for polyester
Buckle & latch	Residual waste

USE IN THE VEHICLE

Please observe the instructions on the use of child restraint systems described in your vehicle owner's manual.

The seat may be used in all vehicles equipped with the ISOFIX and Top Tether anchoring systems. Please consult your vehicle owner's manual for information about the Top Tether anchoring points and the seats which are approved for child safety seats in the weight class 9-18 kg.

You can use your child car seat as follows:

In the direction of travel	Yes
Against the direction of travel	No ¹⁾
On seats featuring: ISOFIX attachments (between seat surface and backrest) and Top Tether anchoring points (for example on the parcel shelf, on the floor or behind the backrest)	Yes ²⁾

(Please observe the applicable regulations in your country)

- Use is permitted on a rearward-facing vehicle seat (e.g. in a van or minibus) only if the vehicle seat is also approved for use by adults. The seat must not be positioned anywhere where it is in range of an airbag which is being deployed.
- If there is a front airbag: Slide the passenger seat a long way back and refer to any instructions in vehicle owner's manual.

NEXT CHILD SAFETY SEATS

BRITAX RÖMER Child safety seats	Testing and certification in accordance with ECE R 44/04	
	Group	Body weight
KID	2 - 3	15 - 36 kg
KID plus	2 - 3	15 - 36 kg
KIDFIX	2 - 3	15 - 36 kg
KIDFIX SICT	2 - 3	15 - 36 kg

TWO-YEAR WARRANTY

For this child safety seat we offer a 2-year warranty against manufacturing or material defects. The warranty period is effective from the day of purchase. The warranty covers only child safety seats which have been handled properly and which have been sent to us in a clean and proper condition.

The Warranty does not cover:

- natural signs of wear and damage resulting from excessive stress
- damage resulting from inappropriate or improper use

What is covered by the warranty?

Fabrics: All of our fabrics meet very high requirements with regard to colour fastness when exposed to UV radiation. Nevertheless, all fabrics fade when exposed to UV radiation. This is not a material defect, but rather a normal sign of wear which is not covered by the warranty.

Buckle: Buckle malfunctions are often due to accumulations of dirt or foreign bodies which may stop the buckle from working properly. If this happens, the buckle can be cleaned, please follow the procedure described in your user instructions.

Please contact your retailer immediately in the event of a warranty claim. He or she will give you the advice and support you need. When processing claims, product-specific depreciation rates will be applied. Please refer to our General Terms and Conditions which are available from your retailer.

Use, care and maintenance

The child safety seat must be used in accordance with the user instructions. We point out expressly that only genuine accessories and replacement parts must be used.

BRITAX RÖMER
Kindersicherheit GmbH
Theodor-Heuss-Straße 9
D-89340 Leipheim
Germany

T: +49 (0) 8221 3670 -199/-299
F: +49 (0) 8221 3670 -210
E.: service.de@britax.com
www.britax.com

BRITAX EXCELSIOR LIMITED
1 Churchill Way West
Andover
Hampshire SP10 3UW
United Kingdom

T: +44 (0) 1264 333343
F: +44 (0) 1264 334146
E.: service.uk@britax.com
www.britax.com

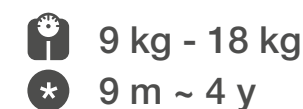

TRIFIX

User Instructions

GB



CARE AND MAINTENANCE

Care for the harness buckle

It is vital for the safety of your child that the harness buckle works correctly. Malfunctions of the harness buckle are usually caused by accumulations of dirt or foreign bodies:

- The buckle latches are ejected only slowly when the red release button is pressed.
- The buckle latches will no longer lock home (i.e. they are ejected again if you try to push them in).
- The buckle latches engage without an audible „click“.
- The buckle latches are difficult to insert (you feel resistance).
- The buckle only opens if extreme force is applied.

Remedy

wash out the harness buckle so that it functions properly once again:

Cleaning the harness buckle

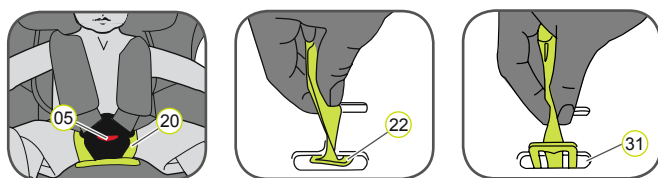

- Open the harness buckle 05 (press the red button).
- Pull the elastic loop over the harness buckle 05.
- Open the Velcro fastener on the crotch pad 20 and take off the crotch pad from the cover.
- Slide the metal plate 22 which is used to fasten the harness buckle 05 to the seat shell up on its edge through the strap slot 31.
- Soak the harness buckle 05 in warm water with dishwashing liquid for at least an hour. Then rinse and dry it thoroughly.

Cleaning

Please be sure to use only genuine Britax/RÖMER replacement seat covers, as the seat cover is an integral part of the child safety seat which plays an important role in ensuring that the system works properly. Replacement seat covers are available from your retailer.

- The child seat must not be used without its cover.
- The cover can be removed and washed with a mild detergent using the

washing machine's cycle for delicate items (30 °C). Please observe the instructions on the washing label of the cover.

- The plastic parts can be cleaned using soapy water. Do not use harsh cleaning agents (such as solvents).
- The harnesses can be washed in lukewarm soapy water.
- Caution:** Never remove the buckle latches 21 from the straps.
- The shoulder pads can be washed in lukewarm soapy water.

Removing the cover

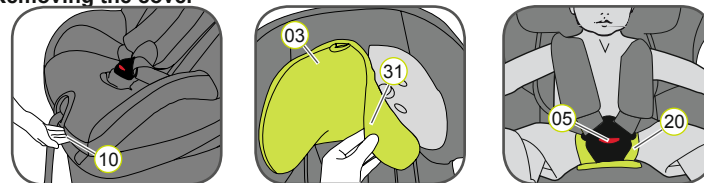

- Press the recline handle 10 upwards and slide the seat shell 18 to the rear into the upright position.
- Loosen the harness straps as far as possible.
- Open the harness buckle 05 (press the red button).
- Open the Velcro fastener on the crotch pad 20.
- Slide the headrest 03 to its lowest position.
- Remove the cover of the headrest 31.
- Open the poppers on the left and right of the rear part of the cover.
- Fold the rear part of the cover onto the seat surface.
- Thread the harness straps through the cutout in the cover.
- Unhook the elastic seam of the cover under the edge of the seat shell.
- TIP: Start at the handles on the side and at the upper edge of the seat shell.
- Pull the cover up and over the bezel of the strap adjuster.
- Feed out the harness buckle 05 and the end of the strap from the cover.
- Pull the cover upwards a little and then put it with the cutout over the headrest 03.

Re-fitting the Cover:

Simply follow the steps in the opposite order.

- Caution:** Check that the harness straps are not twisted and that they have been correctly inserted in the belt slots on the cover.

⚠ Take the time to carefully read through these instructions, and always keep them ready to hand in the designated pocket on the child seat.

⚠ For the protection of all vehicle occupants

In the case of an emergency stop or an accident, persons or objects which are not properly secured in the car can cause injury to other vehicle occupants. For this reason, please always check that...

- the backrests of the vehicle seats are locked (e.g. that the latch on a folding rear seat bench is engaged).
- all heavy or sharp-edged objects in the vehicle (e.g. on the parcel shelf) are secured.
- all persons in the vehicle have their seatbelts fastened.
- the child safety seat is always secured in the car via the ISOFIX anchoring and the Top Tether, even when there is no child in the seat.

⚠ For the protection of your child

- The more snugly the harness fits over your child's body, the safer your child will be.
- Please do not ever leave your child unattended in the child safety seat in the vehicle.

- Use on the rear seat:

Move the front seat forward far enough that your child's feet cannot hit the backrest of the front seat (to prevent risk of injury).

- The child safety seat can get hot in direct sunshine. Caution: Children's skin is delicate and could be injured as a result. Protect the child seat against intensive direct sunlight when it is not currently in use.
- Only allow your child to enter and exit the vehicle on the pavement side.
- Make stops during longer journeys to give your child an opportunity to run about and play.

⚠ To protect your vehicle

Some vehicle seat coverings made of more delicate materials (e.g. velour, leather, etc.) may develop wear marks when child seats are used. For optimum protection of your seat covers, we recommend using the BRITAX RÖMER Car Seat Protector, which is available from our range of accessories.

INSTALLATION

Preparatory work



1. If your vehicle is not equipped with the ISOFIX insert guides as standard, clip the two insert guides 02 which are included with the seat* with the cut-out facing upwards onto the two ISOFIX attachment points 01 of your vehicle.

TIP: The ISOFIX attachment points are located between the surface and the backrest of the vehicle seat.

2. Move the head restraint on the vehicle seat to the upper position.

* The insert guides make it easier to install the child safety seat with the aid of the ISOFIX attachment points and prevent damage to the seat covering. When not in use, they should be removed and stored in a safe place. On vehicles with a folding backrest the insert guides must be removed before the backrest is folded.

Any problems which occur are usually caused by dirt or foreign objects on the insert guides and on the hooks. Clean off any dirt or foreign objects to remedy this type of problem.

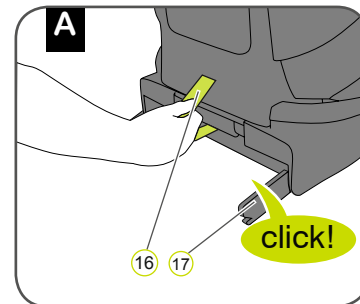

1. Pull the grey fabric loop 16 to pull out both locking arms 17 until you hear a clicking sound which indicates they are fully engaged.

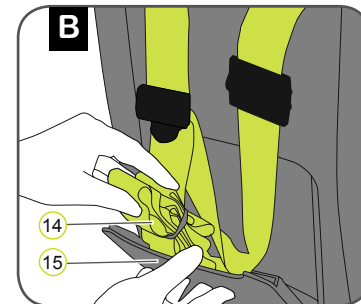

2. Take the Top Tether 14 from the user guide compartment 15 and lay it over the child safety seat.

3. Place the child safety seat facing in the direction of travel on the vehicle seat.

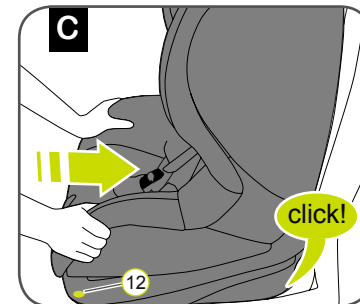

4. Grasp the child safety seat with both hands and slide the two locking arms 17 firmly into the insert guides 02 until the locking arms engage with a clicking noise on both sides.

⚠ Caution: The locking arms are only correctly engaged if both of the ISOFIX indicators 12 are completely green.

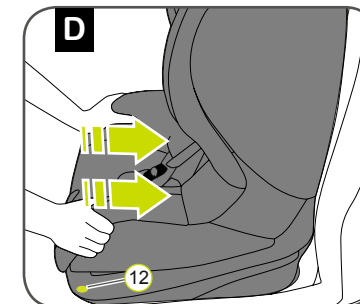

5. Push the child safety seat with a substantial amount of force as far back as it will go.

6. Shake the child safety seat to make sure it is safely attached and re-check to the ISOFIX indicators 12 to make sure that both of them are completely green.

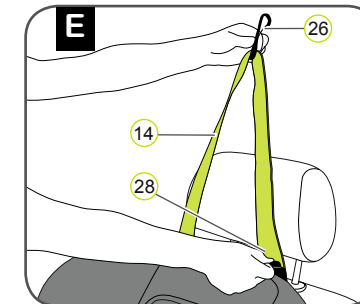

7. Take the Top Tether 14 and press the metal tongue 28 away from the strap to lengthen the strap and pull the Top Tether 14 by the snap hook 26 until it makes a V-shape.

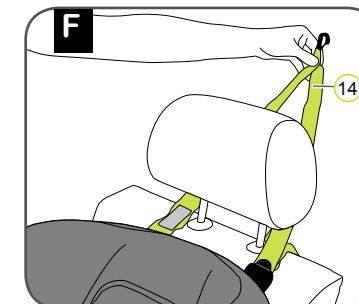

8. Guide the Top Tether 14 on the left and right-hand sides past the headrest.

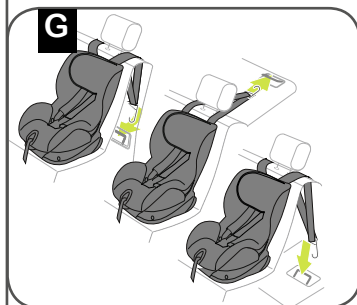

9. Hook the snap hook 26 into the Top Tether anchoring point recommended in your vehicle owner's guide.

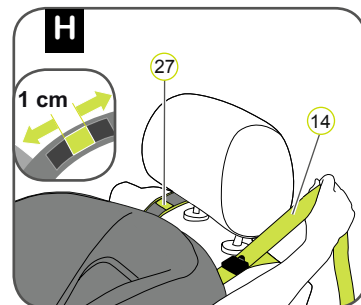

10. Tension the strap of the Top Tether 14 until the tension indicator 27 turns green and the Top Tether 14 is tightly tensioned.

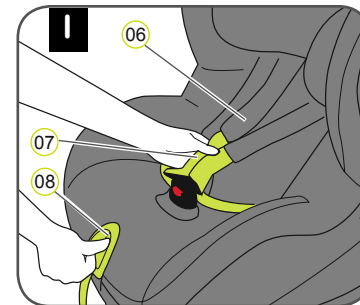

⚠ Caution: Check that the child safety seat is correctly attached

11. Press the adjusting button 08 and at the same time pull both shoulder straps 07 forwards. Caution: Do not pull on the shoulder pads 06.

12. Open the harness buckle 05 (press the red button).

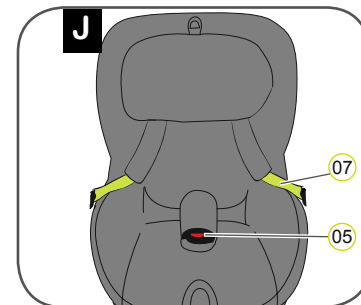

13. Make sure that the buckle 05 is folded forwards and place your child in the child safety seat.

14. Put the shoulder straps 07 over the shoulders of your child.

⚠ Caution: The shoulder straps 07 must not be twisted or swapped.

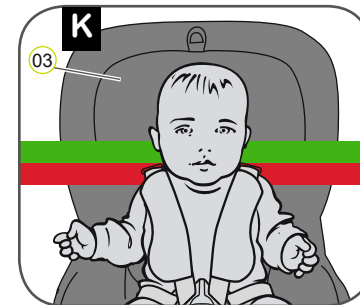

A correctly adjusted headrest 03 ensures optimal protection for your child in the safety seat:

15. The headrest 03 must be adjusted so that the shoulder straps 07 are at the same level as your child's shoulders or slightly above.

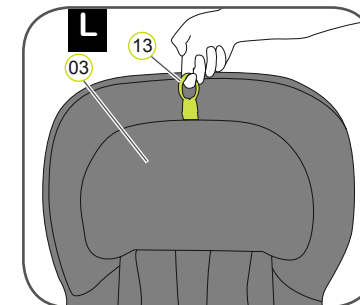

16. Pull the adjusting ring of the head rest 13 upwards

17. Move the head rest 03 to the correct shoulder strap height and check that it is properly engaged by lightly sliding the head rest 03 downwards.

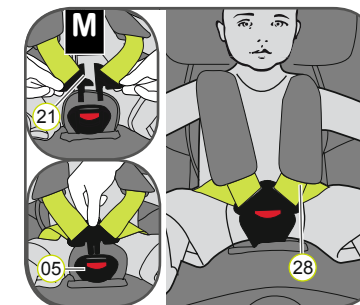

18. Guide the two buckle latches 21 together and engage them before putting them into the harness buckle 05 - this should make a clicking noise.

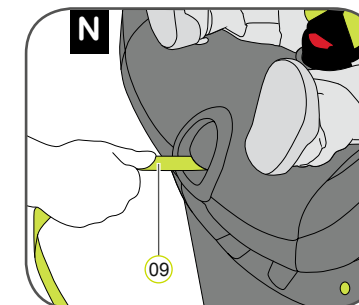

19. Pull on the adjusting strap 09 until the harness lies flat and is close against your child's body.

⚠ Caution: Pull out the adjusting strap to the front.

⚠ Caution: The hip straps 28 must be positioned as low as possible over your child's hips.

⚠ For the safety of your child, before every journey in the car check that...

- the child safety seat is engaged on both sides with the ISOFIX locking arms 17 in the ISOFIX attachment points 01 and that both ISOFIX indicators 12 are completely green;
- the child safety seat is securely fastened;
- the Top Tether 14 is tightly tensioned over the backrest of the car seat and the tension indicator 27 is green;
- the straps of the child safety seat are close to the body without constricting the child;
- the shoulder straps 07 are correctly adjusted and the straps are not twisted;
- the shoulder pads 06 are in the right position on your child's body;
- the buckle latches 21 are engaged in the harness buckle 05.

⚠ Caution: If your child attempts to open the grey ISOFIX locking buttons 11 or the harness buckle 05, make sure to stop at the earliest opportunity. Check that the child safety seat is correctly attached and make sure that your child is properly secured. Teach your child about the dangers involved.

Removing the child safety seat with ISOFIX

1. Loosen the Top Tether 14
 2. Unhook the snap hook 26 from the anchoring point and lay the Top Tether 14 to the front over the child safety seat
 3. Press on the grey ISOFIX unlocking buttons on the left and right-hand side of the seat shell 18.
→ The ISOFIX locking arms 17 will release and the two ISOFIX indicators 12 will change colour to red.
 4. Pull the seat forwards and stow the Top Tether 14 back in the user guide compartment 15.
 5. Slide the ISOFIX locking arms 17 back into the seat shell 18.
→ A rattling noise is produced when the locking arms are pushed back in.
- TIP: The locking arms are protected against damage when they are pushed back into the seat base.

⚠ Caution: Remove the child safety seat from the vehicle. The child safety seat must never be transported in the car if it is not properly secured.